



Life Sciences

Instructions for Use

USD 2896

Cadence™ Single-Use Tangential Flow Filtration (TFF) Modules with Omega™ Membrane

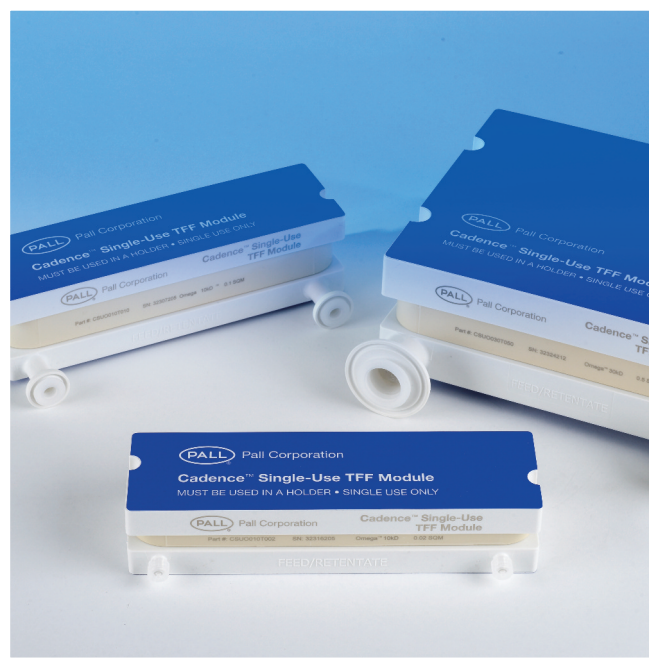

Table of Contents

1. Introduction	4
2. Installation of Cadence Single-use TFF Modules with Omega Membrane	3
2.1 Installation of Cadence Single-use TFF Modules up to 0.1 m ² Membrane Area	3
2.2 Installation of Cadence single-use TFF modules with 0.5 m ² or 2.5 m ² Membrane Area	9
3. Operating Specifications	12
3.1 Recommended Cross Flow Flux (CFF)	12
3.2 Operating Limits	12
4. Preconditioning Cadence Single-use TFF Modules with Omega Membrane	12
4.1 Initial Flushing of the Module and System (WFI Flush)	13
4.2 Sanitizing the Module and System (Optional)	14
4.3 Flushing the Module and System after Sanitization	15
4.4 Determine Hold-up Volume	15
4.5 System and Cadence Single-use TFF Module Integrity Test	16
4.5.1 System Integrity Test	17
4.5.2 Membrane Integrity Test	17
4.5.3 Troubleshooting System and Module Integrity Test Failure	18
4.6 Buffer Conditioning	18
4.6.1 Flush the Retentate and Permeate Lines with Buffer	18
4.6.2 Remove Trapped Air from the Retentate Line	19
5. Processing	20
5.1 TMP Optimization (Optional)	20
5.2 Concentration	21
5.3 Diafiltration	21
5.4 Final Concentration	22
5.5 Product Recovery	22
6. Post-use Decontamination and Disposal	23
7. Scientific and Laboratory Services	23

Safety Notice

Important Notice

Refer to safety instructions before use. Safety instructions in this language are available from Pall.

Viktigt att notera

Läs säkerhetsinstruktionerna före användandet. Säkerhetsinstruktioner på svenska finns att få från Pall.

重要通知

ご使用前に安全にお使いいただくための説明書をお読みください。日本語でかかれた説明書はボールより入手可能です。

Viktig melding

Les Sikkerhetsinstruksjonen før bruk. Sikkerhetsinstruksjon på norsk vil være tilgjengelig fra Pall.

Belangrijke informatie:

Voor gebruik veiligheidsinstructies goed doornemen. Veiligheids instructies in het Nederlands zijn bij Pall verkrijgbaar.

Avvertenza importante

Prima dell'uso leggere le istruzioni per la sicurezza. Le istruzioni per la sicurezza in Italiano possono essere richieste a Pall.

Aviso importante

Antes de utilizar, consultar instruções de segurança. Instruções de segurança em Português, encontram-se disponíveis na Pall.

Aviso importante

Antes de usar, consultar Instrucciones de Seguridad. Instrucciones de Seguridad en este idioma están disponibles por Pall.

Important

Se référer aux instructions concernant la sécurité d'utilisation avant usage. Les instructions concernant la sécurité d'utilisation sont disponibles en français chez Pall.

Viktigt

Læs sikkerhedsinstruktioner før ibrugtagning. Sikkerhedsinstruktioner på dansk kan fås fra Pall.

Tärkeä tiedote

Lue turvallisuusohjeet ennen käyttöä. Pall toimittaa tarvittaessa suomenkieliset turvallisuusohjeet.

Wichtige Anmerkung

Vor Gebrauch bitte die Sicherheitsrichtlinien lesen. Die Sicherheitsrichtlinien in dieser Sprache erhalten Sie von Pall.

Σημαντική Επισήμανση:

Διαβάστε τις Οδηγίες Ασφάλειας πριν από τη Χρήση. Οι Οδηγίες Ασφάλειας στα Ελληνικά είναι διαθέσιμες από την PALL.

Learn About Safety

Please read and follow the safety instructions in this User Guide.

Important – Read First

Pre-use Recommended Storage Conditions

Pall Cadence single-use TFF modules can be expected to perform within specifications if stored and handled in a manner consistent with the parameters below:

- The module is stored unopened in the original packaging at 4 to 25 °C and in a dry environment.
- The module is protected from direct sunlight, radiation, or weather conditions.
- Care is taken to avoid physical damage while handling.
- Thermal shock is avoided.

Check prior to use

As this product is supplied after receiving a gamma irradiation dose of ≥ 25 kGy, please consider only unopened, undamaged packages for use.

Ensure the product is still within shelf life before use.

General recommendations

Solutions recommended for pre-use sanitizing, flushing, and disposal may be hazardous or corrosive. Follow proper safety procedures when preparing, mixing, and handling these reagents. Refer to Material Safety Data Sheets (MSDS) — available from your supplier — to learn about the specific characteristics, necessary precautions, and suitable remedies for each reagent used.

1. Always wear protective clothing including safety glasses and gloves when working with membrane cassettes, equipment, samples, and reagents.
2. Provide sufficient space for assembling all system components and operating the system.

3. Disconnecting a system component or dismantling an installed Cadence single-use TFF module from its holder without first isolating and depressurizing it can result in personal injury and equipment damage. Depressurize a TFF system and the Cadence single-use TFF module before dismantling any component.
4. Some system components may be very heavy. Take proper precautions when moving or lifting equipment to prevent personal injury. In some cases, hoists or other lifting equipment may be required.
5. You should always use pressure gauges or pressure sensing devices in your system so you can monitor the system pressure and differential pressure across the Cadence single-use TFF module.
6. Wipe up spills promptly to prevent injury from contact or slipping.
7. Complete the following safety procedures:
 - a. Read about the operating limits of the Cadence single-use TFF module and the proper methods for use detailed in this User Guide.
 - b. Ensure that your process conditions do not exceed the operating limits of the Cadence single-use TFF module and its holder, sealing materials and the single-use TFF system set-up.
 - c. Check that your process equipment and the TFF holder meet local safety codes.
 - d. Inspect the TFF holder and system regularly to detect damaged components.

Safety Conventions in this Manual

Safety information is identified in this instruction manual by the following convention:

INFORMATION

 **Information:** *Identifies important information about the current topic.*

CAUTION

 **CAUTION:** *Identifies a situation that may cause product damage and may pose a safety risk that can cause personal injury.*

WARNING

 **WARNING:** *Identifies a dangerous or potentially dangerous situation that may cause irreversible damage to equipment and poses a safety risk that can cause serious personal injury.*

1. Introduction

Pall operates a technical service to assist in the application of our products. This service is readily available to you and we welcome your questions so that we can help. In addition, an extensive network of technical representatives is available throughout the world.

 **CAUTION:** *This guide is designed only for Cadence single-use TFF modules with Omega membrane. Its contents and specifications do not apply to other Pall tangential flow filtration membrane cassettes or any other TFF products in general.*

 **CAUTION:** *This document provides instructions guidelines only. The end users need to qualify the single-use TFF operation for the specific requirements of their application.*

The process conditions for using Cadence single-use TFF modules with Omega membrane in a tangential flow filtration (TFF) system depend on the specific application. Important process parameters that must be considered include:

- Retentate flow rate (cross flow rate)
- Transmembrane pressure
- Temperature
- Product characteristics (such as concentration, viscosity, and additives)

Variations in any of these parameters can affect the quality and reproducibility of the TFF process. The operating conditions for any TFF process must be established by performing trials, evaluating results, and then modifying conditions as necessary to achieve the required results. This manual contains detailed steps for the proper installation, preparation and processing of a single-use TFF membrane module and assembly. The procedures include protocols for Cadence single-use TFF modules with Omega membrane.

Some processes may require adaptations to suit the specific requirements of a given system configuration or application, but essential protocols should not be omitted. To perform these procedures, it is recommended that the single-use TFF system include 2 pressure gauges/transducers on the feed and retentate lines and 2 valves for proper execution of the protocols presented, see Figure 1. To include integrity testing capability (highly recommended), additional valves and components may be required.

Single-use TFF (SUTFF) System Configuration

Figure 1

Typical TFF system set-up

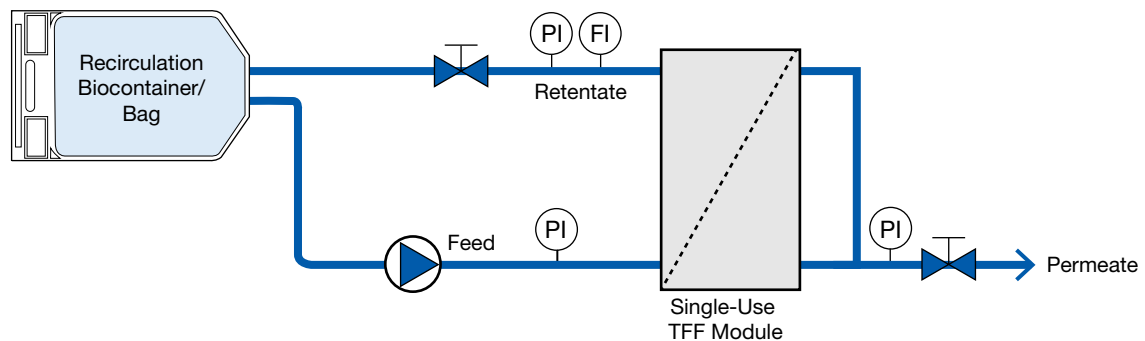

The steps required in a Single-use Tangential Flow Filtration process are displayed in Figure 2.

Information on product process optimization and processing for conventional TFF and diafiltration can be found in other supporting literature, at www.pall.com/biopharm or through Pall Life Sciences Technical Support:

- PN33289 Diafiltration: A Fast Efficient Method for Desalting or Buffer Exchange of Biological Samples
- PN33213 Introduction to TFF for Laboratory and Process Development Applications

Figure 2

Typical single-use TFF process steps

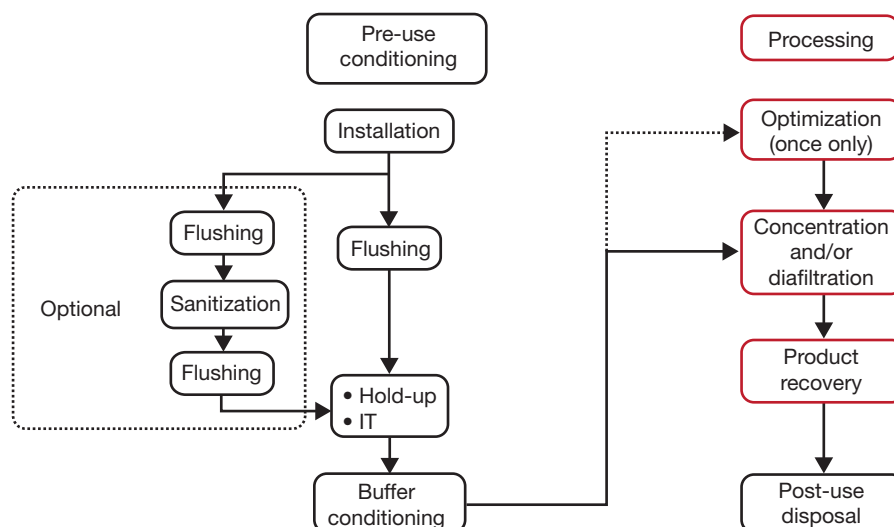

2. Installation of Cadence single-use TFF modules with Omega membrane



INFORMATION: Cadence single-use TFF modules are supplied preassembled, stored in water and gamma irradiated at a minimum of 25 kGy.

We recommend to use them in a Pall Cadence holder for single-use TFF, designed for these modules. Please consult Pall to ensure that an appropriate holder is used. Cadence TFF modules are intended for single-use only and should not be post-use cleaned.



WARNING: The holders must be installed and secured onto a TFF system or onto a frame, to avoid any displacement of the holder, which could lead to operator safety issues or to process issues.

2.1 Installation of Cadence Single-use TFF Modules up to 0.1 m² Membrane Area



1. Take the fully assembled holder and swing out the swing rods as shown in photograph.



2. Insert the module onto the Cadence holder bottom rod, making sure to align the notch onto the bottom rod.

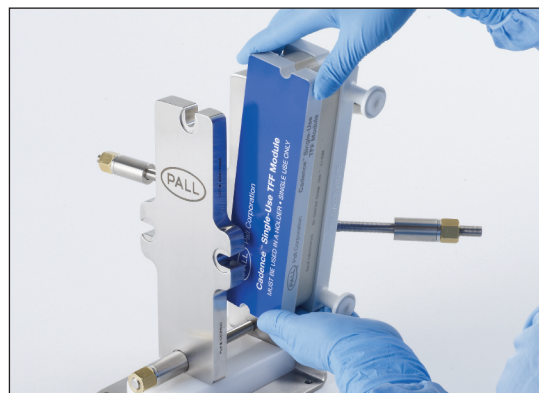

3. Make note of the module orientation and ensure it is correctly aligned with the feed/retentate/permeate lines in your system. Feed / retentate and permeate ports are identified on the side of the module manifold, as shown on the photographs.



Detail of the marking on the module side:



4. Swing the holder rods back into the locked position.



5. Before connecting the system tubing and/or torquing the Cadence single-use TFF module, please make sure to remove each of the four caps or plugs from the connection ports on the feed, retentate, and permeate.

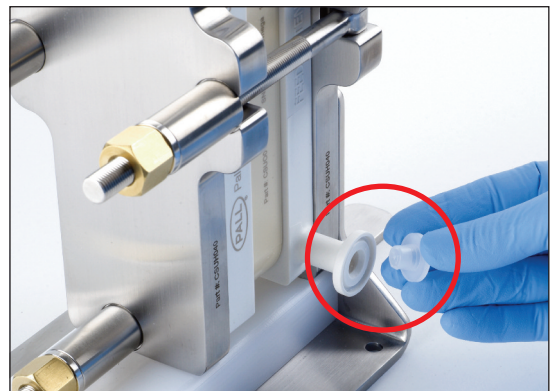

6. Connect the system tubing to the Cadence single-use TFF module ports after removing each individual cap/plug. Do not forget to install the gaskets for the connections as appropriate. Pall can provide Allegro™ single-use TFF systems and single-use tubing sets for single-use TFF process solutions.

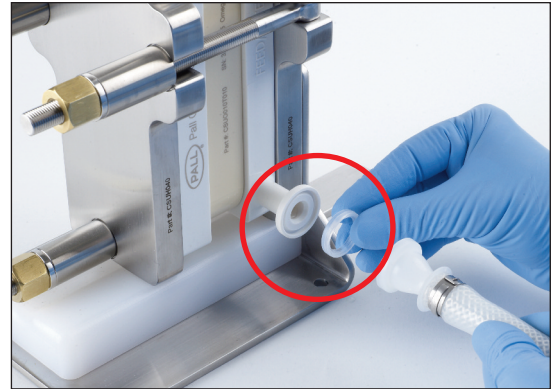

CAUTION: Please make sure that the tubing sets are supported adequately and do not create any mechanical constraint on the connection ports. This could potentially damage the ports and compromise the assembly integrity.

7. Hand tighten the silicone bronze nuts equally against the washers.

Set the calibrated torque wrench provided to the nominal torque setting (Table 1)

- Cadence single-use TFF modules with up to 0.1 m² membrane area (Centramate™ format) require a nominal torque setting of 90 in- lbs (10 Nm), when installed in a Pall Cadence CM holder with 4 bolts.

Table 1

Recommended torque ranges for Pall Cadence single-use TFF modules up to 0.1 m² membrane area

Holder type	Number of bolts on holder	Recommended torque range for manual torque holders	
		in-lbs	Nm
Cadence CM holder for single-use TFF modules (Centramate format)	4	80-100	9-11

8. Tighten the silicone bronze nuts using the torque pattern sequence shown below. Do not turn the nuts more than ¼ turn at a time. After reaching a ¼ turn, begin tightening the next nut in the specified sequence.

Example of ¼-turn Torque Procedure

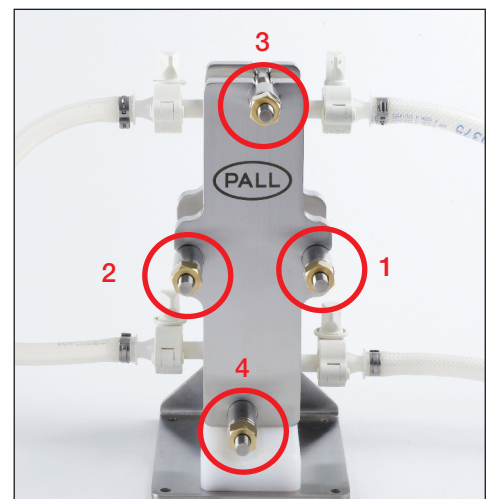
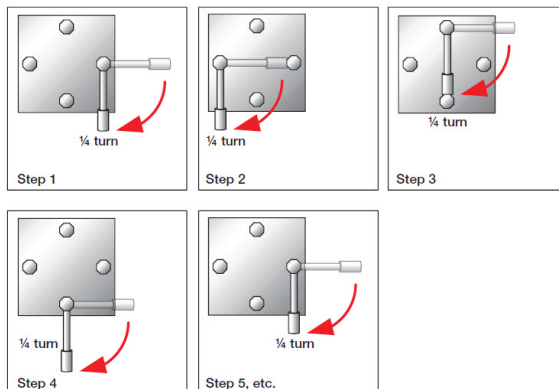

9. Tighten nuts in this sequence until the specified torque value is reached. Stop tightening each nut immediately when the torque wrench “clicks,” or the wrench arm pivots slightly away from the socket indicating that the nut has reached the correct torque.

Continue torquing each nut in sequence until the torque wrench “clicks” immediately on each nut in sequence. If torqued properly, the nuts should reach the set torque value at about the same time. The indication that the torque wrench has reached the set value may be very subtle. Therefore, tighten the nuts slowly to prevent exceeding the required torque value.



CAUTION: A non uniform or improper torque of the Cadence single-use TFF module can lead to damage, leakage or product loss.

2.2 Installation of Cadence single-use TFF modules with 0.5 m² or 2.5 m² membrane area



WARNING: The holders must be installed and secured onto a TFF system or onto a frame, to avoid any displacement of the holder, which could lead to operator safety issues or to process issues.

1. Take fully assembled holder and remove the rods as shown in photograph.



2. Insert the module onto the Cadence holder bottom rods, making sure to align the notch onto the bottom rods.

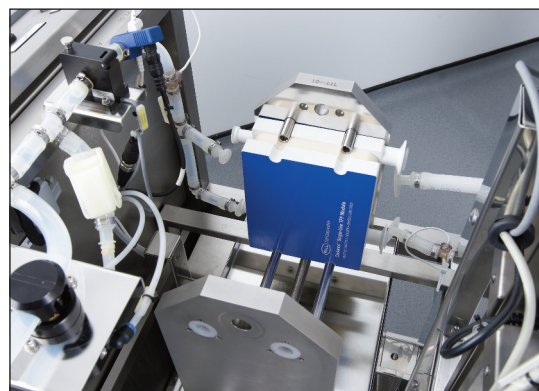

3. Make note of the module orientation and ensure it is correctly aligned with the feed / retentate / permeate lines in your system. Feed / retentate and permeate ports are identified on the side of the module manifold, as shown on the photographs.

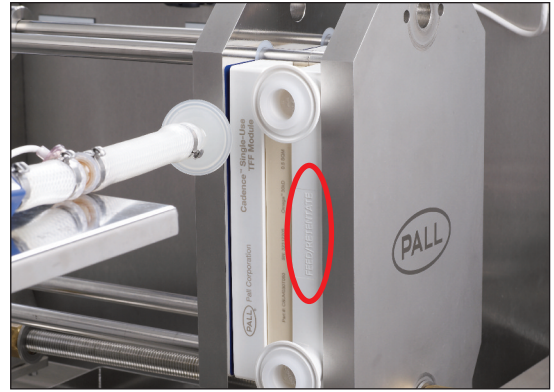

Detail of the marking on the module side:



4. Add the upper rods on the holder as shown.

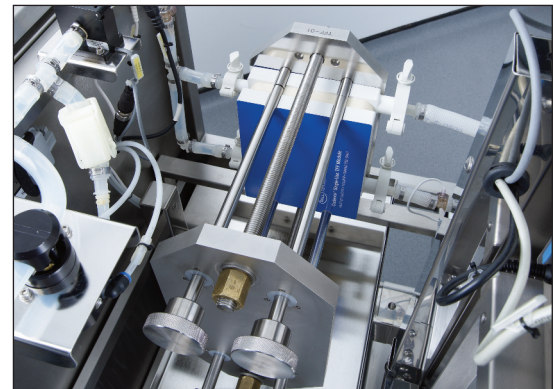

5. Before connecting the system tubing and/or torquing the Cadence single-use TFF module, remove each of the four plugs from the feed, retentate, and permeate ports.



- Connect the system tubing to the Cadence single-use TFF module ports after removing each individual cap/plug. Do not forget to install the gaskets for the connections as appropriate. Pall can provide Allegro™ single-use TFF systems and single-use tubing sets for single-use TFF process solutions.



CAUTION: Please make sure that the tubing sets are supported adequately and do not create any mechanical constraint on the connection ports. This could potentially damage the ports and compromise the assembly integrity.

- Hand tighten the silicone bronze nuts equally.

Set the calibrated torque wrench provided to nominal torque setting (Table 2)

- Cadence single-use TFF modules with 0.5 to 2.5 m² membrane area (Centrasette™ format) require a nominal torque setting of 900 in-lbs (102 Nm), when installed in a Pall Cadence CS holder with 2 bolts.

Table 2

Recommended torque ranges for Pall Cadence single-use TFF modules with 0.5 m² or 2.5 m² membrane area

Holder type	Number of bolts on holder	Recommended torque range for manual torque holders	
		in-lbs	Nm
Cadence CS holder for single-use TFF modules (Centrasette format)	2	700-1100	80-125

- Tighten the silicone bronze nuts using the torque pattern sequence shown in the photograph. Do not turn the nuts more than ¼ turn at a time. After reaching a ¼ turn on nut 1, begin tightening the nut 2, then tighten nut 1, followed by nut 2 and repeat this sequence.

- Tighten nuts in this sequence until the specified torque value is reached. Stop tightening each nut immediately when the torque wrench “clicks,” or the wrench arm pivots slightly away from the socket indicating that the nut has reached the correct torque.



Continue torquing each nut in sequence until the torque wrench “clicks” immediately on each nut in sequence. If torqued properly, the nuts should reach the set torque value at about the same time. The indication that the torque wrench has reached the set value may be very subtle. Therefore, tighten the nuts slowly to prevent exceeding the required torque value.



CAUTION: A non uniform or improper torque of the Cadence single-use TFF module can lead to damage, leakage or product loss.

3. Operating Specifications

3.1 Recommended Cross Flow Flux (CFF)

Table 3 lists recommended cross flow flux (CFF) for operating Cadence single-use TFF modules with Omega membrane. Other parameters such as transmembrane pressure (TMP) and temperature can be evaluated at these CFF values.

CFF = L/min/ft² or L/min/m² or L/hour/m² [retentate flow rate/membrane area]

Table 3

Recommended cross flow fluxes (CFF) for processing and pre-use sanitization

Units	Minimum CFF Processing mode	Recommended CFF Processing mode and pre-use sanitization
L/min/m ²	3	5-8
L/min/ft ²	0.3	0.5-0.8
L/hour/m ² (LMH)	180	300-480

3.2 Operating limits

Operating limit specifications for pressure, temperature, and pH as well as typical times are listed in Table 4

Table 4

Operating limits of Cadence single-use TFF modules with Omega membrane

Recommended maximum operating feed pressure	4 barg (58 psig)
Maximum transmembrane pressure (TMP)	4 barg (58 psig)
Temperature range during processing	4-40 °C
Typical operating time	8 hours
Temperature range during pre-use sanitization	18-25 °C
Typical pre-use sanitization time	30 minutes
pH range at 18-25 °C	2-14



WARNING: Exceeding the maximum operating pressure for the Cadence single-use TFF modules can cause permanent damage.

4. Preconditioning Cadence single-use TFF modules with Omega membrane

Before processing product, several steps must be performed (Figure 3) to assure that the Cadence single-use TFF modules are properly installed in the holder and fit-for-use to prevent possible sample loss.

Cadence single-use TFF modules with Omega membrane are delivered pre-flushed, stored in water, and gamma irradiated. They can be considered as ready to use.

No pre-use sanitization should be required prior to processing. Depending on the assembly procedure with the TFF system and based on the end-user risk assessment, a sanitization step may be utilized.

This preconditioning process consists of the following steps:

Figure 3

Steps for preconditioning Cadence single-use TFF modules

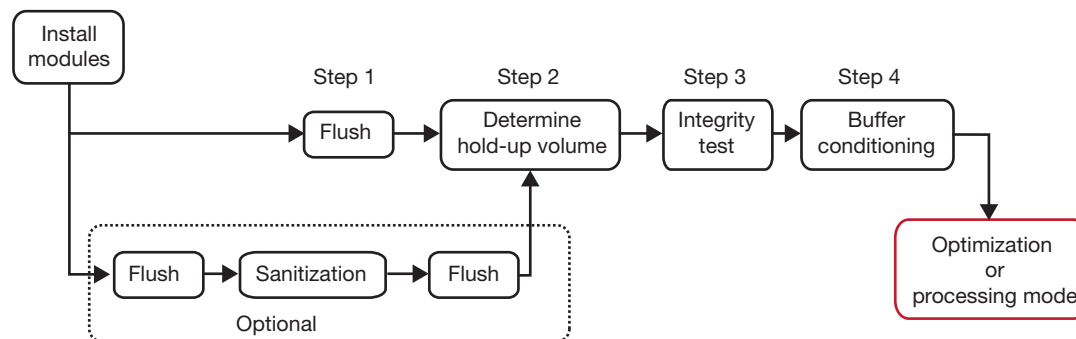

Step 1 is a short flush, which removes the bulk of the water storage solution, so only a small quantity of water is required in this step.

Step 2 measures the combined system and module hold-up volume for a given system setup. This step is required only when using a given system setup for the first time.

Step 3 establishes the integrity of the single-use TFF modules and system against leaks and possible product loss.

Step 4 corresponds to the buffer conditioning. It prepares the wetted surfaces of the system as well as the membrane in the module before the addition of process fluid by removing trapped air from the system and equilibrating the system in the process buffer to reduce the risk of product precipitation or denaturation. It also equilibrates the system temperature to the product temperature.

Optional steps are designed to sanitize the whole system assembly with the modules pre-use, if needed. Flushing volumes must be determined by the end user for the specific application.

Details of each step are presented in the following sections.

4.1 Initial Flushing of the Module and System (WFI Flush)

Objective: To remove water that was used as the storage solution.

Water Quality for Flushing: WFI (water for injection) or 0.2 µm filtered deionized (DI) water at ambient T° (typically 18-25 °C)

Recommended Volume: 20 L/m² (2 L/ft²)

Figure 4

System set-up for flushing

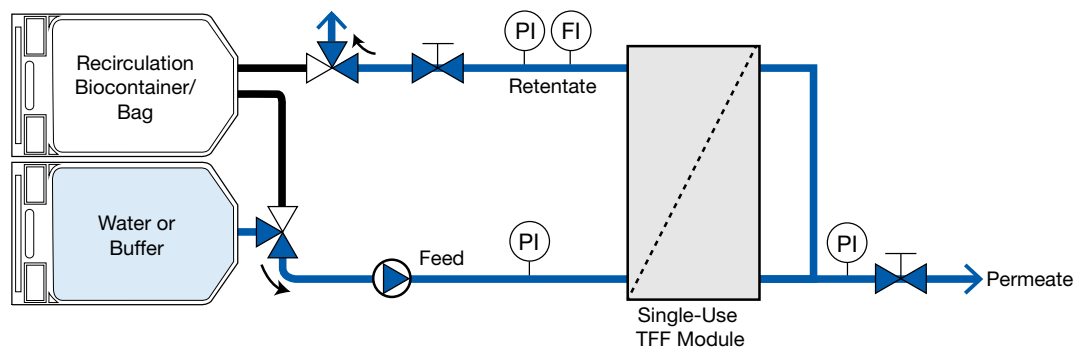

Procedure

1. Fill the water biocontainer with WFI or DI water.
2. Direct retentate and permeate lines to waste.
3. Fully open the retentate and permeate valves to waste.
4. Adjust the feed pump to deliver a feed CFF of 5-8 L/min/m² (0.5-0.8 L/min/ft²). Do not exceed a feed pressure of 2 barg (30 psig).
 - a. Adjust the retentate valve to split flow 25% retentate, 75% permeate.
 - b. Re-adjust the pump to give required feed CFF.
5. Flush a minimum of 20 L/m² (2 L/ft²) DI water to waste until a desired TOC, conductivity or neutral pH is achieved. Actual required volumes might vary, depending on the application requirements.
6. Stop the pump.

4.2 Sanitizing the Module and System (Optional)



Sanitization step can be skipped depending on end-user's risk assessment and assembly method. If no pre-use sanitization step is required for your process, proceed with determination of hold-up volume (if required), integrity testing, and buffer conditioning.

The following agent and conditions are recommended for sanitizing the specific Cadence single-use TFF modules with Omega membrane:

Volume Required: 5 L/m² (0.5 L/ft²)

Sanitizing Solutions: 0.1 to 0.5 N NaOH at 18-25 °C

Typical Time: 30 minutes

Maximum Sanitization Time: 45 minutes



WARNING: *Ensure proper safety procedures are followed while handling, mixing and preparing the sanitization solution.*

Figure 5

Set-up for recirculating sanitizing fluid

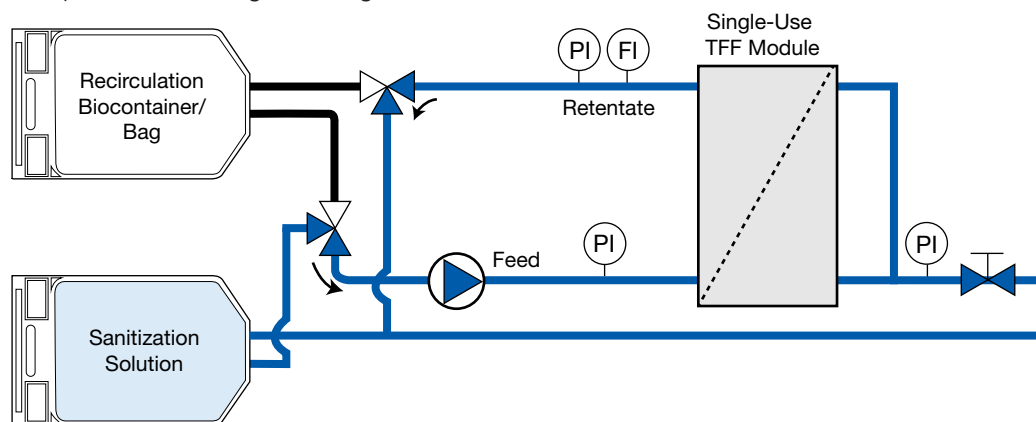

Procedure

1. Connect the biocontainer with sanitizing solution.
2. Fully open the retentate and permeate valves. Direct both lines to waste. Refer to system set-up for flushing
3. Adjust the feed pump to deliver a feed pressure of 1 to 1.5 barg (15-22 psig) and a feed CFF of 5-8 L/min/m² (0.5-0.8 L/min/ft²).

- After all the lines are flooded, direct retentate line and the permeate lines into the sanitization solution biocontainer, as shown on Figure 5 (Set-up for recirculating sanitizing fluid).
- Re-adjust the pump to maintain the feed pressure of 1 to 1.5 barg (15-22 psig).
- Recirculate sanitizing agent from feed to retentate for 30 minutes.
- Stop the pump.



CAUTION: *The user must evaluate and validate the effectiveness of the process with respect to time and temperature and the effectiveness of the sanitizing agent for their process.*

4.3 Flushing the Module and System after Sanitization



If no sanitization is performed, this step is not required

Water Quality: WFI or 0.2 µm filtered DI water at ambient temperature (18-25 °C).

Volume Required: minimum 40 L/m² (4 L/ft²) (exact volume required may vary according to end user specifications)

Figure 6

System set-up for flushing

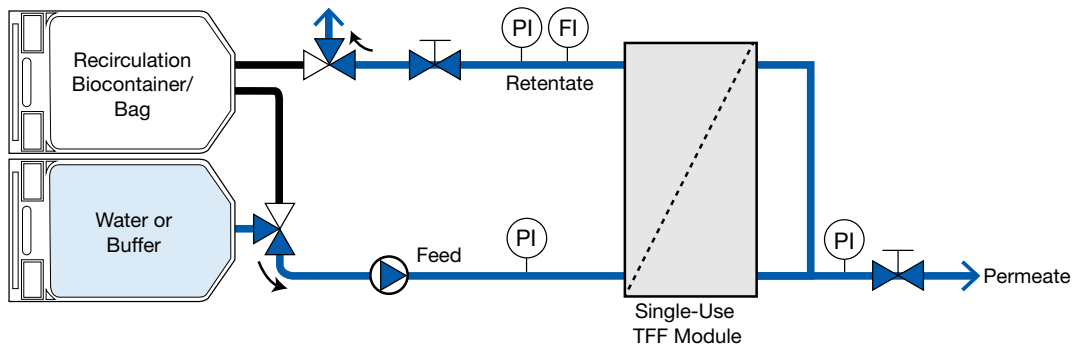

Procedure

- Connect the WFI or DI water biocontainer.
- Direct retentate and permeate lines to waste.
- Fully open the retentate and permeate valves to waste.
- Adjust the feed pump to deliver a feed CFF of 5-8 L/min/m² (0.5-0.8 L/min/ft²). Do not exceed a feed pressure of 2 barg (30 psig).
 - Adjust the retentate valve to split the flow to approximately 25% retentate and 75% permeate.
 - Re-adjust the pump to give recommended CFF.
- Flush a minimum of 40 L/m² (L/ft²) DI water to waste until a desired conductivity or neutral pH is achieved. Stop the pump.



CAUTION: *The effectiveness of this flushing protocol to reduce or eliminate the sanitant will depend on the end user specific criteria and acceptable levels. The user must evaluate and validate the effectiveness of the process with respect to time, temperature and other operating conditions of the Cadence single-use modules and the single-use TFF system.*

4.4 Determine Hold-up Volume

This procedure includes steps to determine the combined system and module hold-up volume for a given system set-up.

Most of the total volume contained within the feed/retentate flow path is recoverable.



For subsequent process runs, assuming that the system set-up and module size has not changed, this step is not required.



Depending on the single-use system design, a specific procedure might be required for the hold-up volume determination.

Follow these steps to determine the hold-up volume:

1. Open the feed and retentate valves and close the permeate valve.
2. Direct the retentate line to a collection vessel or biocontainer.
3. Disconnect the feed line from previous supply of fluid.
4. Check that the system set-up is designed and rated for the below pressure. If not, define a suitable lower pressure.
5. Using the system pump to supply clean air to the feed port, pressurize the feed to 1.3 barg (20 psig). Alternatively, another source of filtered, oil-free, instrument-quality compressed air can be used to pressurize the feed to 1.4 (20 psig).
6. Wait until all fluid in the module is pushed out of the retentate port. Only air should be flowing from the retentate port.
7. Stop the air flow into the feed port.
8. Measure the retentate volume and record the value as the system hold-up volume.

Please note that minimum working volume is the hold-up volume plus a minimum volume of liquid that must remain in the the feed vessel of biocontainer at the operating flow rate to prevent air from being drawn into the TFF system.

4.5 System and Cadence single-use TFF module Integrity Test

Air diffusion (or forward flow) is a quantitative test that measures the rate of air diffusing through the wetted membrane or seal defects at a given pressure differential. Since the measurements are relative, air diffusion rates can be performed on Cadence single-use TFF modules wetted with water or buffer solution.



Before performing a Forward Flow integrity test on a Cadence single-use TFF module, the membrane must be completely wetted.



WARNING: *Before performing the integrity test, make sure that the TFF system design is capable of handling required test conditions, especially the pressure conditions.*

There are two important steps to the integrity test protocols:

1. System Integrity Test (IT)

The system IT checks the external seals, fittings, plumbing and gasket assemblies within the pressurized feed/retentate flow path for leaks.

2. Cadence single-use TFF module IT

The Cadence single-use TFF module IT checks the membrane and internal seal assemblies within the Cadence single-use TFF modules for defects.

The system IT is usually performed first. This assures that any air flow measured during the Cadence single-use TFF module IT is not the result of an external leak.

Performing a system IT is recommended, but not required. If the Cadence TFF single-use module IT passes, the integrity of the membranes and system is confirmed. However, if the Cadence single-use TFF module IT fails, then the system IT should be performed to confirm that no external leaks contribute to the measured air flow.

Figure 7

System set-up for performing the system integrity test

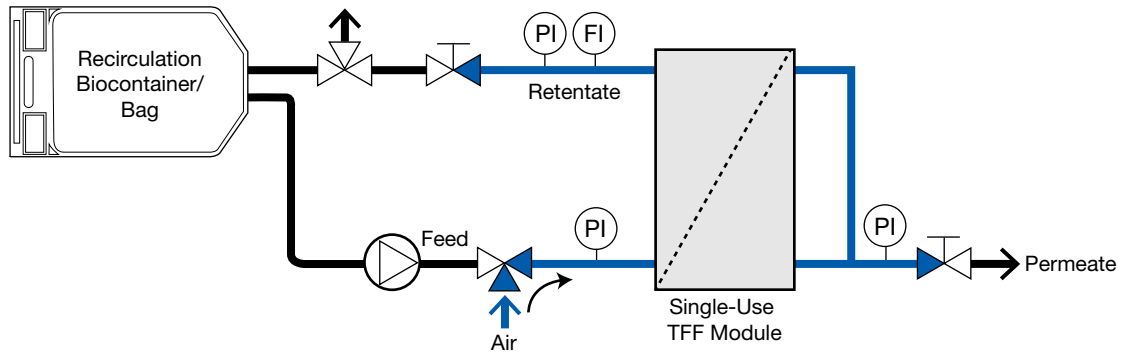

4.5.1 System Integrity Test

Procedure

1. Drain the system:
 - a. Direct retentate and permeate lines to waste.
 - b. Close permeate valve and force the water from feed to retentate at a $P_{\text{FEED}} < 1.3$ barg (20 psig). Then, drain the permeate lines.
2. Connect air pressure source and close permeate valve and any other valves in the feed and retentate flow path as required to allow the system to be pressurized with air.
3. Pressurize the system to 2 barg (30 psig) for Cadence single-use TFF modules with Omega membrane.
 - a. Close the air pressure source and monitor the pressure decay
 - b. If pressure decay is below 70 mbarg/min (1 psig/min) or the air flow rate is zero mL/min, the system IT has passed, otherwise, check the system for leaks.

Once the system IT has been completed, slowly open the retentate valve to reduce the air pressure to zero psig.

4.5.2 Membrane Integrity Test

Procedure

1. If the system IT has not been performed, drain the system:
 - a. Direct retentate and permeate lines to waste.
 - b. Close permeate valve and force the water from feed to retentate at a $P_{\text{FEED}} < 1.3$ barg (20 psig). Then, drain the permeate lines.
2. Connect air pressure source, close retentate valve and make sure that the permeate valve is open.
3. Pressurize the system to 2 barg (30 psig) for Cadence single-use TFF modules with Omega membrane
 - a. Turn on the air supply and monitor the permeate air flow rate.
 - b. The membrane is integral if permeate air flow rate is ≤ 1600 mL/min/m² (150 mL/min/ft²) normalized to 20 °C, for Cadence single-use TFF modules with Omega membrane.

Once the module IT has been completed, slowly open the retentate valve to reduce the air pressure to zero barg (psig).

Figure 8

System set-up for performing the membrane integrity test

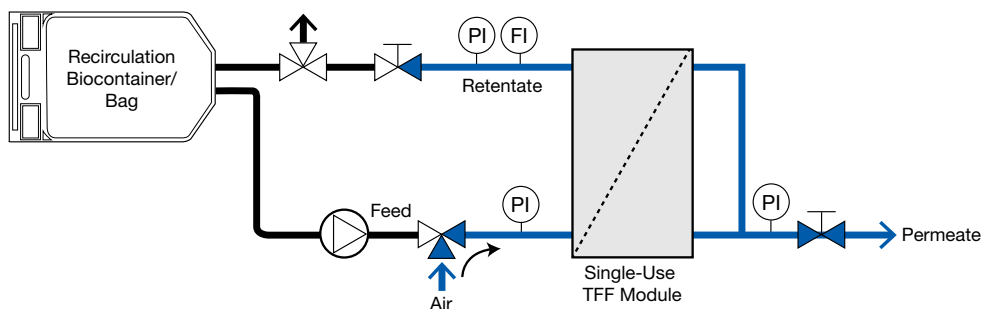

4.5.3 Troubleshooting System and Module Integrity Test Failure

If the integrity test fails, please check the following:

1. Check the torque on the manual holder. Check the Cadence single-use TFF module installation.
2. Check all connections and fitting assemblies to assure they are securely tightened.
3. Repeat the system IT, Section 4.5.1.
4. Repeat the Cadence single-use TFF module IT, Section 4.5.2. If the Cadence single-use TFF module still fails IT, contact your local Pall representative for assistance.

4.6 Buffer Conditioning

Buffer conditioning the Cadence single-use TFF module and TFF assembly is critical for most biopharmaceutical applications. Buffer conditioning removes trapped air from the Cadence single-use TFF module and system and establishes conditions for pH, ionic strength and temperature to match the process sample.

This is important to prevent sample precipitation or denaturation when the feed/product is first introduced into the system. For this operation, use the same buffer that was used to prepare the sample. The buffer must be at the same temperature as the process fluid.



Cadence single-use TFF modules and hardware that are subject to substantial temperature changes (> 10 °C) will require a torque adjustment to be made on the holder after steady state is reached. For example, if the hardware surface temperature is 20 to 25 °C and fluid is introduced at 4 °C, the torque on a Cadence single-use TFF module may decrease by 20 to 40% due to contraction of the polymeric elements. In such cases, integrity testing should be performed after all adjustments have been made.

4.6.1 Flush the Retentate and Permeate Lines with Buffer

Typical volume of buffer required: 5 to 20 L/m² (0.5 to 2 L/ft²).



If the system is already drained, proceed to Section 4.6.2 to set-up for recirculation. If not, direct the retentate and permeate lines to waste.

Figure 9

Set-up for buffer conditioning - Initial flush

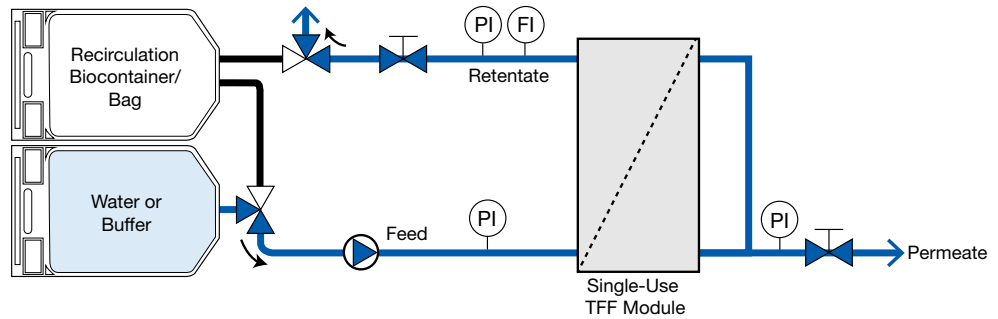

Procedure

1. Connect the buffer biocontainer.
2. Open the permeate and retentate valves to waste.
3. Start the pump and increase pump speed until liquid begins to flow through both the retentate and permeate lines (no more than 2 barg or 30 psig). If necessary, adjust the retentate valve to force flow through permeate.
4. Run for 5 to 10 seconds, then stop.

4.6.2 Remove Trapped Air from the Retentate Line

Figure 10

Set-up for buffer conditioning- Recirculation

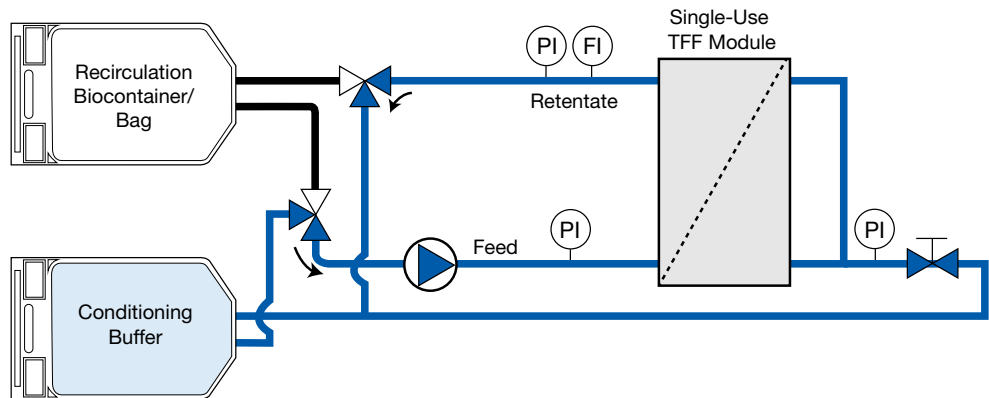

Procedure

1. Direct retentate and permeate lines into the conditioning buffer biocontainer.
2. Fully open the retentate and permeate valves.
3. Recirculate the buffer from feed to retentate and permeate at a feed pressure of 1 to 1.5 barg (15-22 psig).
4. Remove any trapped air during recirculation by opening and closing retentate and permeate valves individually.
5. Run for about 5 minutes.



It is necessary to determine the system hold-up volume in the feed/retentate flow path. This volume will dilute the process fluid and must be considered when calculating concentration factor. Refer to the corresponding section in this document.

5. Processing

A typical TFF unit operation consists of Transmembrane Pressure (TMP) optimization (optional), initial concentration, diafiltration, final concentration, and product recovery steps. A brief description of each step is outlined below. However, the exact protocols for each step should be determined by the end-user. Please note that, initial and target protein concentrations to be sampled and analyzed for the below steps using UV-Vis absorbance or desired assay method. Need for additional assays (viscosity, turbidity, aggregates etc.) to be determined by the end-user.

5.1 TMP Optimization (Optional)

To find the reasonable operating conditions (pressures, flow rates) for processing, a TMP optimization step should be performed at the desired feed/retentate Cross Flow Flux (CFF), TMP, or feed side differential pressure.

The transmembrane pressure is the average differential pressure from the upstream side of the membrane (applied pressure) and the downstream side (permeate):

$$\text{TMP} = \left(\frac{P_{\text{feed}} + P_{\text{retentate}}}{2} \right) - P_{\text{permeate}}$$

The feed side differential pressure, called ΔP , is the difference between the feed pressure and the retentate pressure.

This TMP optimization step is performed only during the product development steps.

Pall operates a technical service to perform trials and to assist in the definition of the recommended operating conditions for your specific application. Please contact Pall for more details on this service.

Figure 11

System set-up for TMP optimization

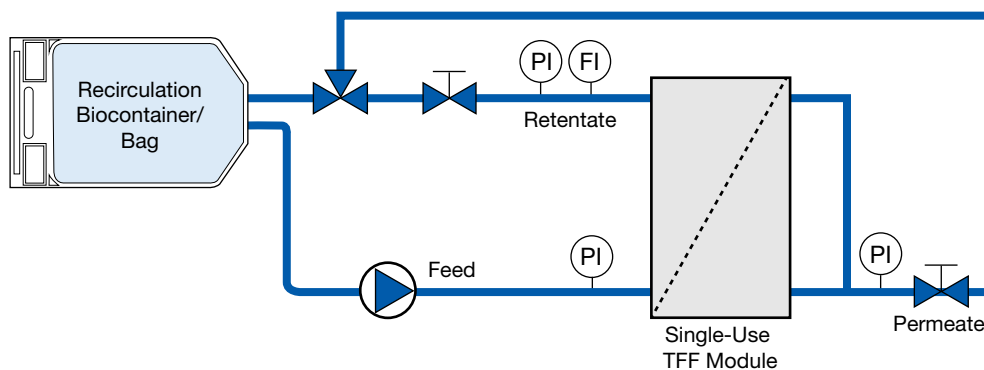
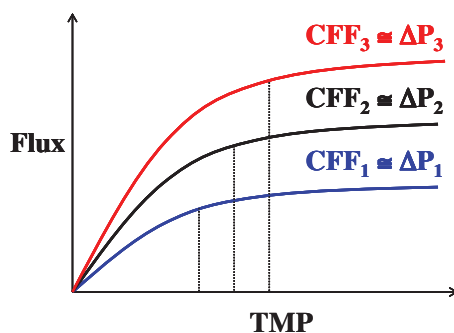

Figure 12

Typical flux versus TMP curves



5.2 Concentration

As outlined in Figure 13, monitor the flux at a set TMP, feed side ΔP or CFF ($L/min/m^2$) until the target concentration is achieved.

Figure 13

Flux versus concentration (log scale)

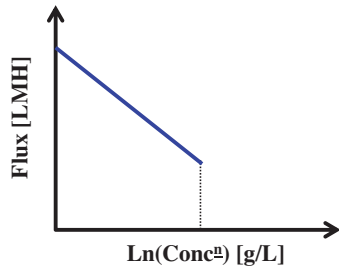
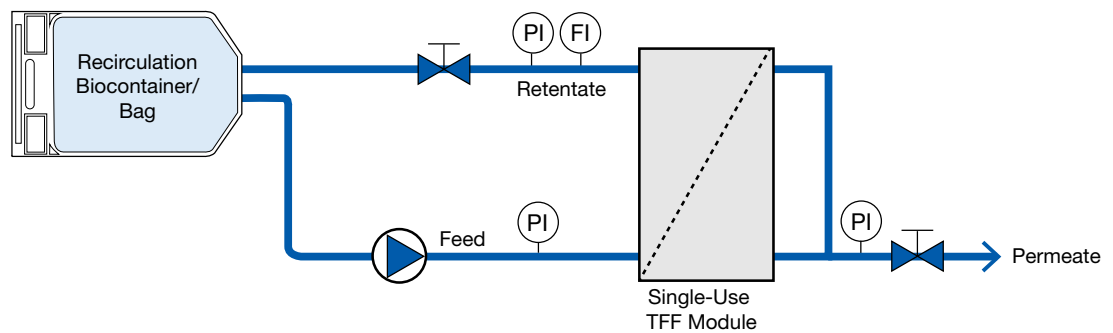

Figure 14

System set-up for product concentration



5.3 Diafiltration

Conduct a constant volume continuous diafiltration until desired removal factor or number of diafiltration volumes is achieved. Please note that this step requires buffer and permeate flow rates to be equal in order to maintain a continuous constant volume operation. A typical system set-up is outlined in Figure 15.

Figure 15

System set-up for constant volume diafiltration

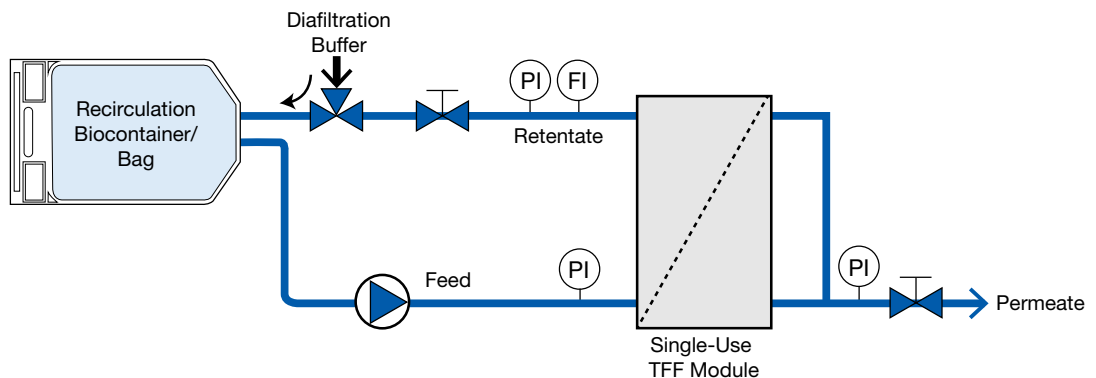

5.4 Final Concentration

As outlined in Figure 16, monitor the flux at a set TMP, feed side ΔP or CFF ($L/min/m^2$) until target concentration is achieved.

Figure 16

Flux versus concentration (log scale)

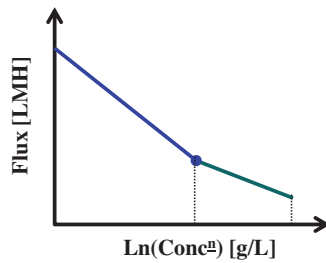
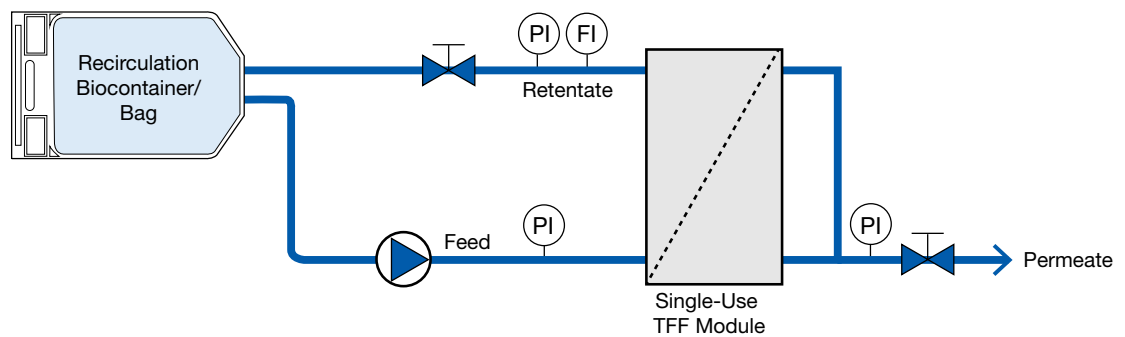

Figure 17

System set-up for final concentration step



5.5 Product Recovery

To recover the product remaining in the module and in the flow path, the following steps should be followed using the generic recovery method outlined in Figure 18. Please note that the product recovery method also depends on the TFF system design.

Procedure

1. Connect a recovery biocontainer to the retentate outlet as shown in Figure 18.
2. Fully open the retentate valve and close the permeate valve.
3. At a low feed pressure, i.e., 0.7-1.3 barg (10-20 psig) collect the product from the recirculation biocontainer, module and flow path into the recovery biocontainer.

For optimum product recovery, an additional buffer flush of the system can be carried out.

Figure 18

System set-up for product recovery

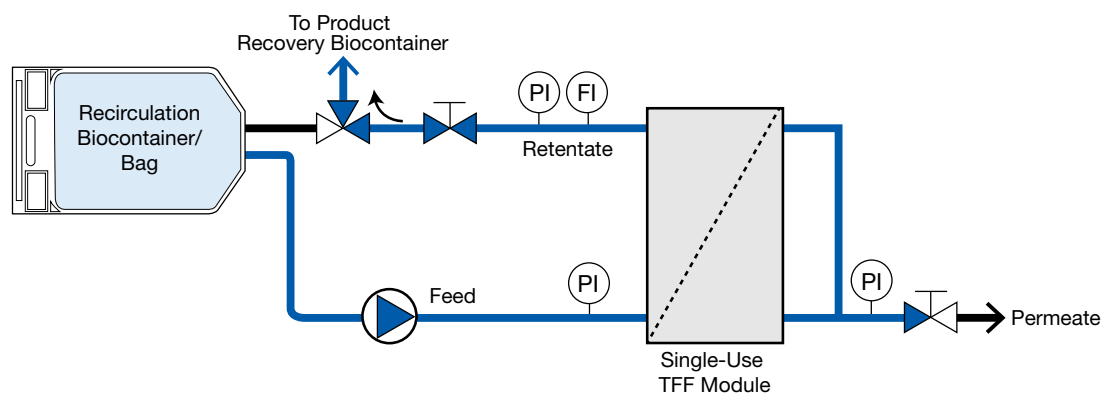

6. Post-use Decontamination and Disposal

Upon completion of the processing and product recovery steps, the Cadence single-use TFF module and system flowpath should be discarded per codes or standards set in your country or region. This may include autoclaving or incinerating the disposable products (module and tubing). Please refer to standard guidelines to develop the disposal protocol.

In some cases, a post-use decontamination or inactivation of the whole TFF system should be performed prior to disassembly.

For post-use decontamination and to inactivate the product, end-users may use the following protocol:

1. Fill the feed vessel or biocontainer with NaOH solution (maximum of 1 M) at ambient temperature (18-25 °C). The solution temperature should not exceed 25 °C.
2. Fully open the retentate and permeate valves. Direct both lines to waste.
3. Adjust the feed pump to deliver a feed pressure of about 1 barg (15 psig).
4. After all lines are flooded, direct retentate line into the feed vessel or biocontainer and close the permeate valve.
5. Re-adjust the pump to maintain the feed pressure of about 1 barg (15 psig).
6. Circulate NaOH solution from feed to retentate for desired amount of time (maximum of 1 hour)
7. Stop the pump.
8. Fill the feed vessel or biocontainer with DI water.
9. Direct retentate and permeate lines to waste.
10. Flush DI water at a maximum feed pressure of 1 barg (15 psig, with 75% of the flow going through the permeate and 25% through the retentate.
11. Flush a minimum of 40 L/m² DI water through the module. Stop the pump.

Please note that this step is optional and may change depending on customer application and containment requirements and on TFF system design.



CAUTION: *The maximum NaOH decontamination time is 1 hour at ambient temperature (18-25 °C). Longer periods of time or higher temperature may affect the integrity of the module structure and compromise the containment.*

Alternatively, the leftover product within the single-use TFF module and flow path may be collected in a hazardous waste container while system is being drained. Then, both the module and the disposable tubing sets can be capped prior to disassembly.

To be able to remove the Cadence single-use TFF module from its holder, the following is recommended:

1. Use a wrench to loosen each of the four nuts.
2. Swing out the holder rods.
3. Remove and cap the module and the tubing from the TFF system and proceed with end-user defined disposal protocols. Please note that, depending on the single-use flowpath, the module can stay connected to the tubing during the disassembly and disposal procedure.

7. Scientific and Laboratory Services

Pall operates a technical service to assist in the application of our products. This service is readily available to you and we welcome your questions so that we can help. In addition, an extensive network of technical representatives is available throughout the world.



Life Sciences

Corporate Headquarters

Port Washington, NY, USA
+1 800 717 7255 toll free (USA)
+1 516 484 5400 phone
biopharm@pall.com e-mail

European Headquarters

Fribourg, Switzerland
+41 (0)26 350 53 00 phone
LifeSciences.EU@pall.com e-mail

Asia-Pacific Headquarters

Singapore
+65 6389 6500 phone
sgcustomerservice@pall.com e-mail

Filtration. Separation. Solution.SM

Visit us on the Web at www.pall.com/allegro

E-mail us at allegro@pall.com

International Offices

Pall Corporation has offices and plants throughout the world in locations such as: Argentina, Australia, Austria, Belgium, Brazil, Canada, China, France, Germany, India, Indonesia, Ireland, Italy, Japan, Korea, Malaysia, Mexico, the Netherlands, New Zealand, Norway, Poland, Puerto Rico, Russia, Singapore, South Africa, Spain, Sweden, Switzerland, Taiwan, Thailand, the United Kingdom, the United States, and Venezuela. Distributors in all major industrial areas of the world. To locate the Pall office or distributor nearest you, visit www.pall.com/contact.

The information provided in this literature was reviewed for accuracy at the time of publication. Product data may be subject to change without notice. For current information consult your local Pall distributor or contact Pall directly.

© 2013, Pall Corporation. Pall, , Allegro, Cadence, Centramate, and Omega are trademarks of Pall Corporation. ® indicates a trademark registered in the USA and TM indicates a common law trademark. **Filtration.Separation.Solution.SM** is a service mark of Pall Corporation.